

Φ10×3.4t Coin Type Vibration Motor

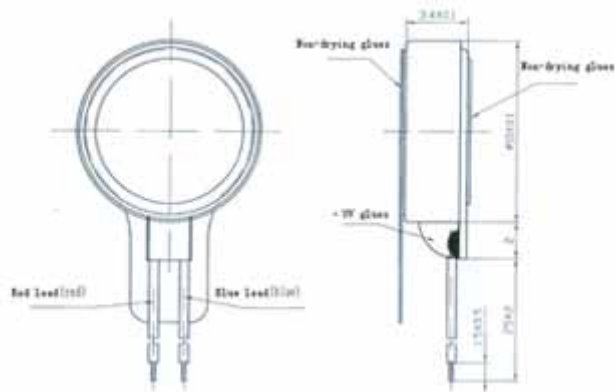

Enlarge

Φ10×3.4t Coin Type Vibration Motor

Name: Φ10×3.4t Coin Type Vibration Motor

Model: B1034

Applications:

- Mobile phone
- PCS (Personal Communication by Satellite)

Specification: Different structures of non-drying glues, rubber bearings and leads are available according to your requirements.